

Data Sheet



Article number: 021816011230

Description: Clamp with bracket and rubber
SPGU 6011. 230/30 SK

Measures

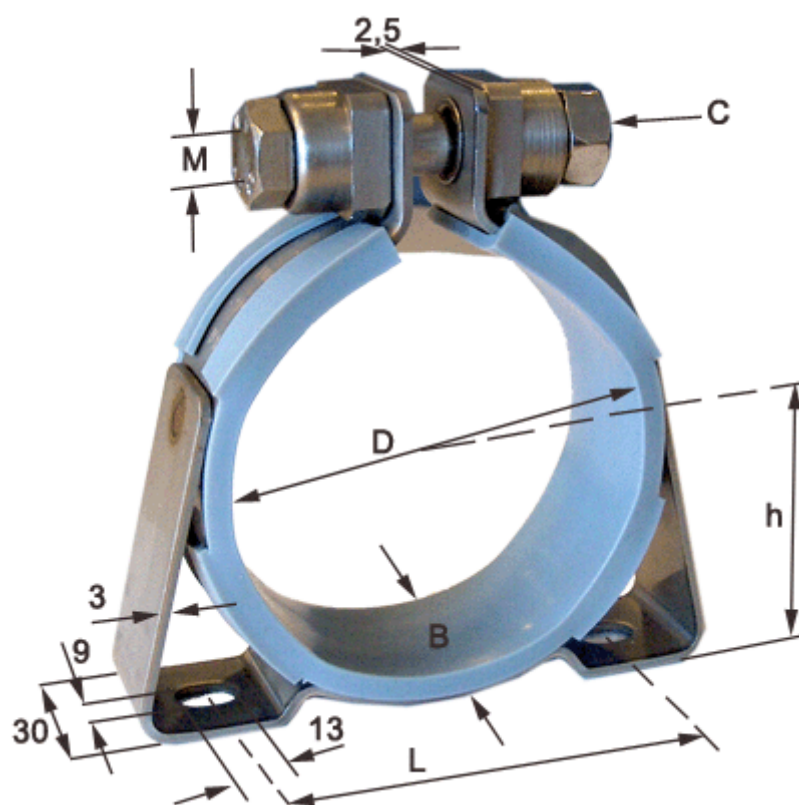

C (screw type) = SK hexagon screw

Diameter D = 230

h = 123

L = 216

Width B = 30